

MwT-7F 26 GHz Medium Power GaAs FET

Features:

- 21 dBm Output Power at 12 GHz
- 15 dB Small Signal Gain at 12 GHz
- Excellent for High Linear Gain or Oscillator Applications
- Ideal for Commercial, Military, Hi-Rel Space Applications
- 0.25 Micron Refractory Metal/Gold Gate
- 250 Micron Gate Width
- Choice of Chip and Three Package Types

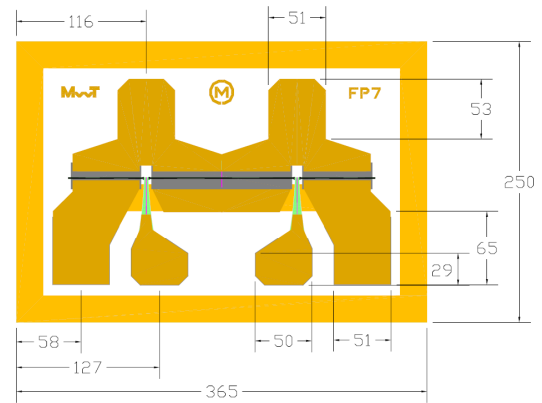

Chip Dimensions: 365 x 250 microns
Chip Thickness: 100 microns

Description:

The MwT-7F is a GaAs MESFET device whose nominal 0.25 micron gate length and 250 micron gate width make it ideally suited to applications requiring high-gain and medium linear power in the 500 MHz to 26 GHz frequency range. MwT-7F is equally effective for either wideband (e.g., 6 to 18 GHz) or narrow-band applications. Processing which guarantees low phase noise makes the MwT-7F particularly attractive for oscillator applications. All chips are passivated with SiN (Silicon Nitride).

RF Specifications: • at $T_a = 25\text{ }^\circ\text{C}$

PARAMETERS & CONDITIONS	SYMBOL	FREQ	UNITS	MIN	TYP
Output Power at 1dB Compression $V_{ds}=7.0\text{V}$ $I_{ds}=0.6 \times I_{DSS}$	P1dB	12 GHz	dBm		21.0
Output Third Order Intercept Point $V_{ds}=7.0\text{V}$ $I_{ds}=0.6 \times I_{DSS}$	OIP3	12 GHz	dBm		32
Power Added Efficiency $V_{ds}=7.0\text{V}$ $I_{ds}=0.6 \times I_{DSS}$	PAE	12 GHz	%		35
Small Signal Gain $V_{ds}=7.0\text{V}$ $I_{ds}=0.6 \times I_{DSS}$	SSG	12 GHz	dB	14.0	15.0
Optimum Noise Figure $V_{ds}=4.0\text{V}$ $I_{ds}=20\text{mA}$	NF Opt	12 GHz	dB		2.0
Gain @ Opt NF $V_{ds}=4.0\text{V}$ $I_{ds}=20\text{mA}$	GA	12 GHz	dB		8.0

DC Specifications: • at $T_a = 25\text{ }^\circ\text{C}$

PARAMETERS & CONDITIONS	SYMBOL	UNITS	MIN	TYP
Saturated Drain Current $V_{ds}= 4.0\text{ V}$ $V_{GS}=0.0\text{V}$	I_{DSS}	mA		77
Transconductance $V_{ds}= 2.0\text{ V}$ $V_{GS}=0.0\text{V}$	G_m	mS		42
Pinch-off Voltage $V_{ds}= 3.0\text{ V}$ $I_{DS}=0\text{mA}$	V_p	V		-2.0
Gate-to-Source Breakdown Voltage $I_{gs}= -1.0\text{ mA}$	BVGS0	V	-14	-15
Gate-to-Drain Breakdown Voltage $I_{gd}= -1.0\text{ mA}$	BVGDO	V	-14	-15
Thermal Resistance <i>MwT-7F Chip, 71 Pkg 70 Pkg & 73 Pkg</i>	R_{th}	$^\circ\text{C/W}$		

*Overall R_{th} depends on case mounting

MwT-7F

26 GHz Medium Power GaAs FET

MwT-7F, Typical Power at 12GHz
 $V_{ds}=7V$; $I_{ds}=0.6 \times I_{DSS}$

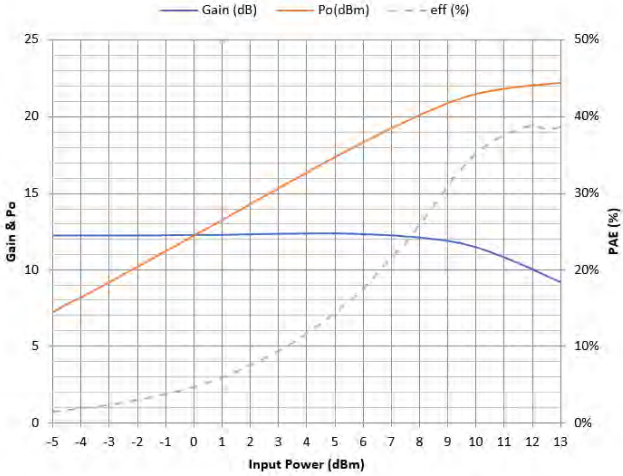

MwT-7F, Typical Power at 18GHz
 $V_{ds}=7V$; $I_{ds}=0.6 \times I_{DSS}$

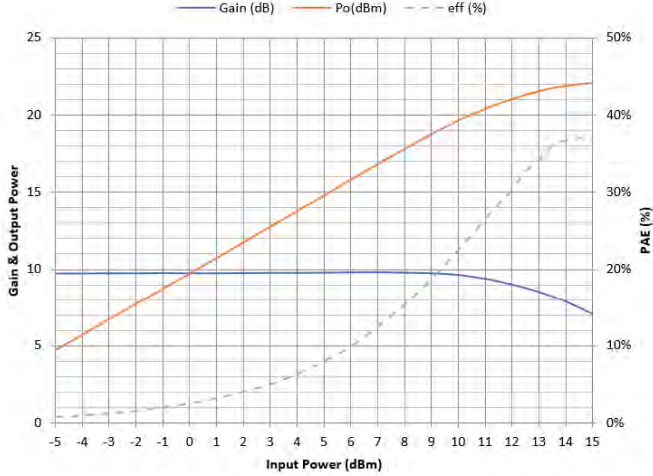

MwT-7F

26 GHz Medium Power GaAs FET

**MwT-7F
DUAL BIAS**

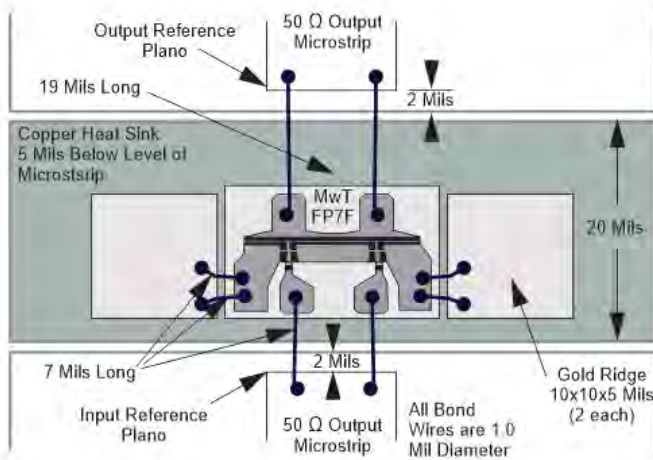

**MwT-7F
OPTIONAL BONDING**

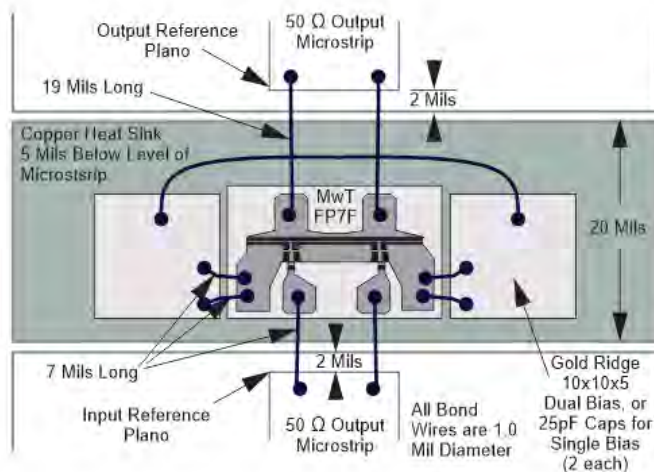

SAFE OPERATING LIMITS vs BACKSIDE TEMPERATURE
MwT-7F Chip & 71 pkg

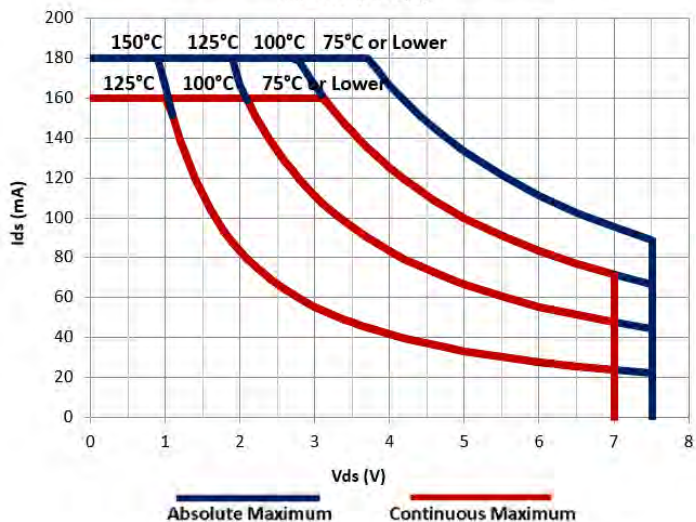

SAFE OPERATING LIMITS vs BACKSIDE TEMPERATURE
MwT-7F with 70 pkg & 73 pkg

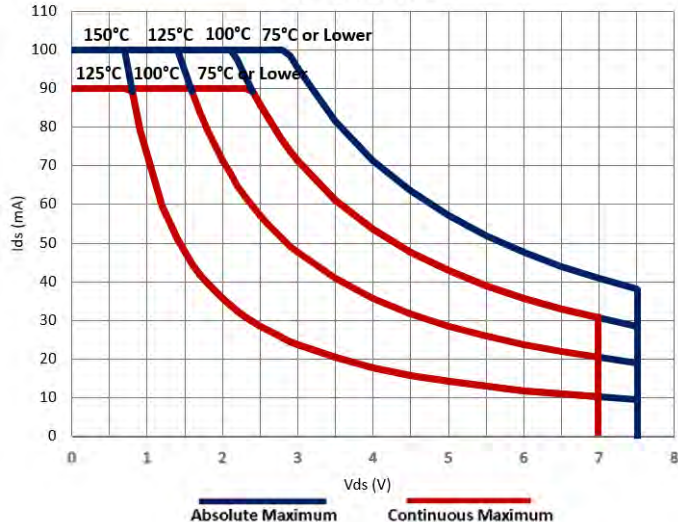

MAXIMUM RATINGS AT Ta = 25 °C

Symbol	Parameter	Units	Cont Max1	Absolute Max2
VDS	Drain to Source Volt.	V	See Safe Operating Limits	
Tch	Channel Temperature	°C	+150	+175
Tst	Storage Temperature	°C	-65 to +150	+175
Pin	RF Input Power	mW	80	120

Notes:

1. Exceeding any one of these limits in continuous operation may reduce the mean-time- to-failure below the design goal.
2. Exceeding any one of these limits may cause permanent damage.

MwT-7F

26 GHz Medium Power GaAs FET

S-PARAMETER Vds=6V, Ids= 0.7 x Idss

Freq. GHz	S11		S21		S12		S22		K	GMAX dB
	dB	Ang (°)	dB	Ang (°)	dB	Ang (°)	dB	Ang (°)		
1	-0.498	-10.990	10.175	170.686	-41.693	81.458	-2.335	-4.381	0.893	25.934
2	-0.582	-21.883	10.025	161.933	-35.631	76.775	-2.392	-9.029	0.537	22.828
3	-0.595	-32.489	9.882	153.342	-32.571	71.286	-2.479	-12.917	0.416	21.226
4	-0.854	-41.958	9.630	145.248	-30.386	65.747	-2.545	-16.709	0.482	20.008
5	-1.012	-52.008	9.248	137.024	-28.750	61.358	-2.669	-20.685	0.491	18.999
6	-1.317	-60.380	8.819	129.651	-27.611	56.034	-2.719	-24.087	0.585	18.215
7	-1.308	-70.683	8.482	122.074	-26.643	51.065	-2.921	-26.615	0.572	17.563
8	-1.647	-76.766	8.087	115.568	-26.098	47.441	-3.019	-31.051	0.683	17.093
9	-1.679	-83.673	7.872	108.759	-25.185	44.458	-3.073	-37.449	0.621	16.528
10	-1.921	-93.421	7.409	101.968	-24.956	39.335	-3.200	-39.572	0.727	16.182
11	-1.759	-99.388	7.018	96.243	-24.529	36.131	-3.496	-42.818	0.714	15.773
12	-1.902	-106.018	6.738	90.372	-24.161	32.319	-3.402	-46.227	0.736	15.450
13	-2.146	-112.957	6.439	84.479	-24.083	29.700	-3.217	-50.391	0.773	15.261
14	-2.181	-120.728	5.965	77.818	-23.951	26.960	-3.360	-53.920	0.820	14.958
15	-1.903	-124.452	5.685	73.257	-23.920	24.396	-3.348	-57.984	0.744	14.802
16	-2.323	-130.428	5.198	67.592	-23.824	22.045	-3.472	-60.964	0.934	14.511
17	-2.494	-137.360	4.811	61.971	-23.939	19.772	-3.595	-64.451	1.052	12.986
18	-2.210	-143.696	4.517	56.014	-24.051	17.966	-3.513	-68.062	0.960	14.284
19	-2.108	-146.372	4.175	52.126	-23.983	16.273	-3.504	-72.649	0.936	14.079
20	-2.212	-150.234	3.768	46.823	-24.214	14.476	-3.446	-77.164	1.031	12.911
21	-2.512	-155.237	3.491	43.152	-24.378	14.523	-3.455	-80.552	1.179	11.372
22	-2.194	-159.572	3.120	38.548	-24.300	14.126	-3.392	-84.296	1.040	12.481
23	-2.023	-162.750	2.795	32.613	-24.657	12.653	-3.225	-88.295	1.007	13.204
24	-2.232	-164.405	2.399	29.542	-25.011	13.683	-3.086	-91.882	1.150	11.354
25	-2.215	-169.779	2.116	25.191	-24.712	13.904	-3.060	-95.917	1.088	11.606
26	-1.983	-172.505	1.650	21.285	-24.875	15.290	-2.987	-100.029	1.000	13.262

Available Packaging:

- 70 Package - MwT-7F70
- 71 Package - MwT-7F71
- 73 Package - MwT-7F73

Contact Information

For additional information please visit www.cmlmicro.com or contact a sales office.

Europe	America	Asia
<ul style="list-style-type: none">• Maldon, UK• Tel +44 (0) 1621 875500• sales@cmlmicro.com	<ul style="list-style-type: none">• Winston-Salem, NC• Tel +1 336 744 5050• us.sales@cmlmicro.com	<ul style="list-style-type: none">• Singapore• Tel +65 6288129• sg.sales@cmlmicro.com

Although the information contained in this document is believed to be accurate, no responsibility is assumed by CML for its use. The product and product information is subject to change at any time without notice. CML has a policy of testing every product shipped using calibrated test equipment to ensure compliance with product specification.

© 2023 CML Microsystems Plc